

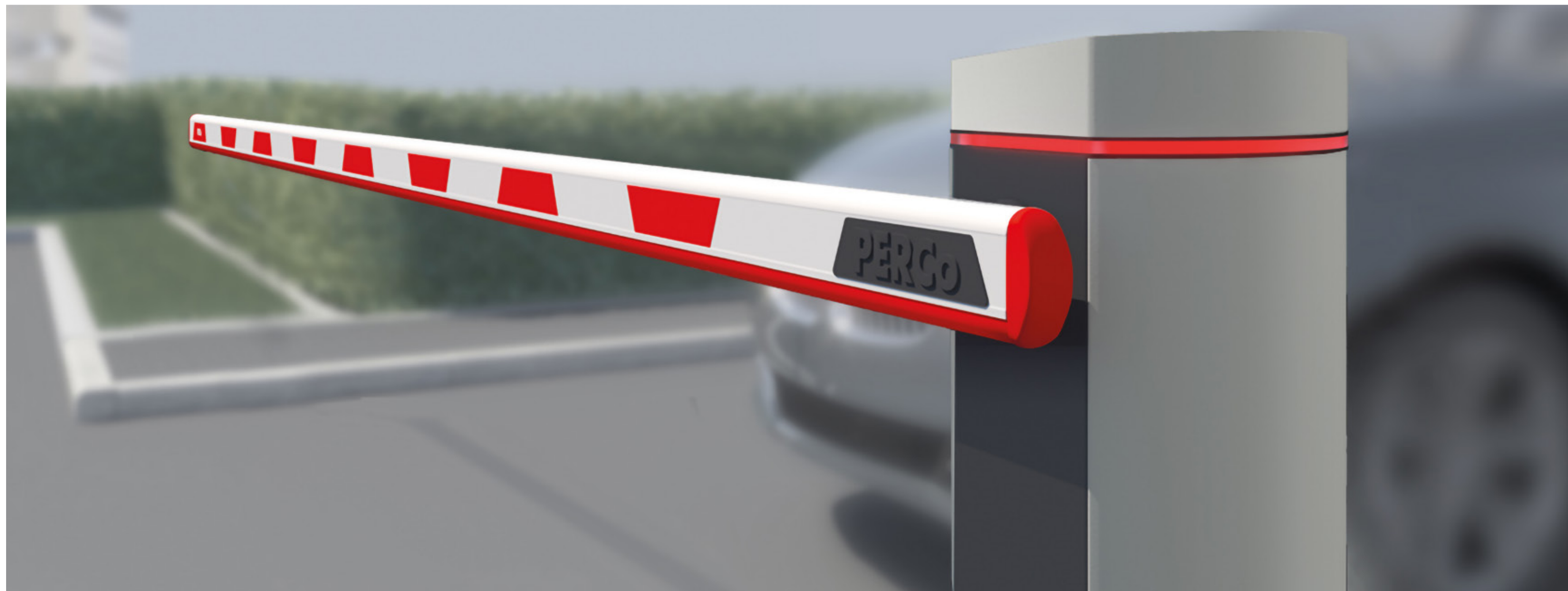

Шлагбаум PERCo-GS-04



Разработан с учетом специфики эксплуатации в России





лет гарантии

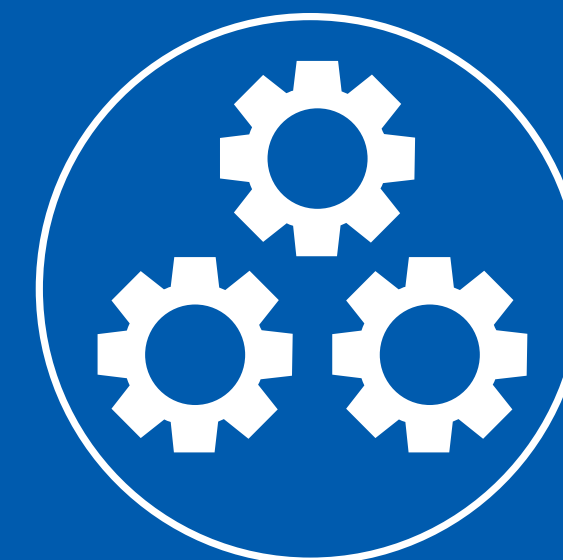

долговечный двигатель



циклов

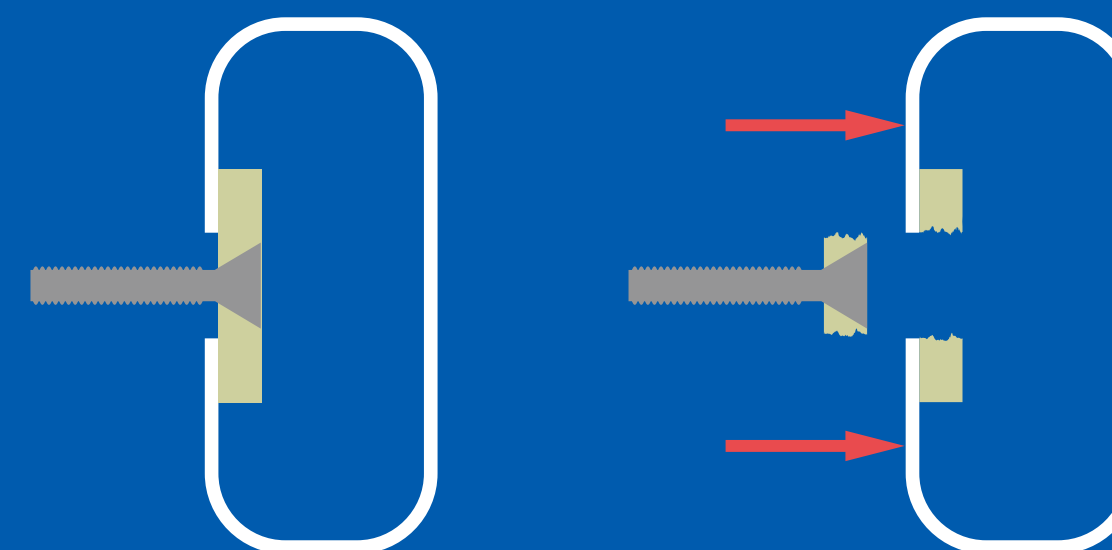

защита механизма управления

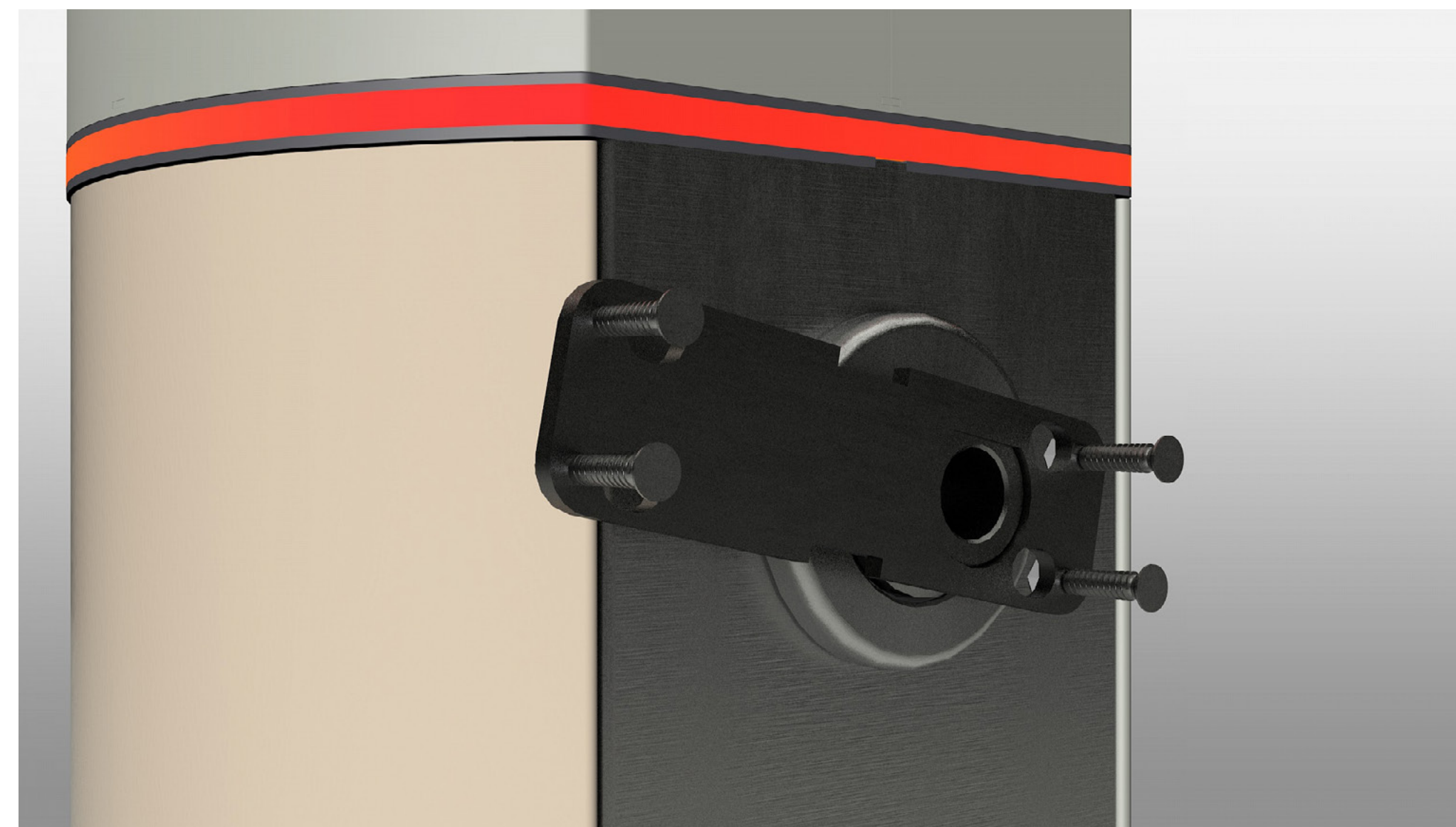
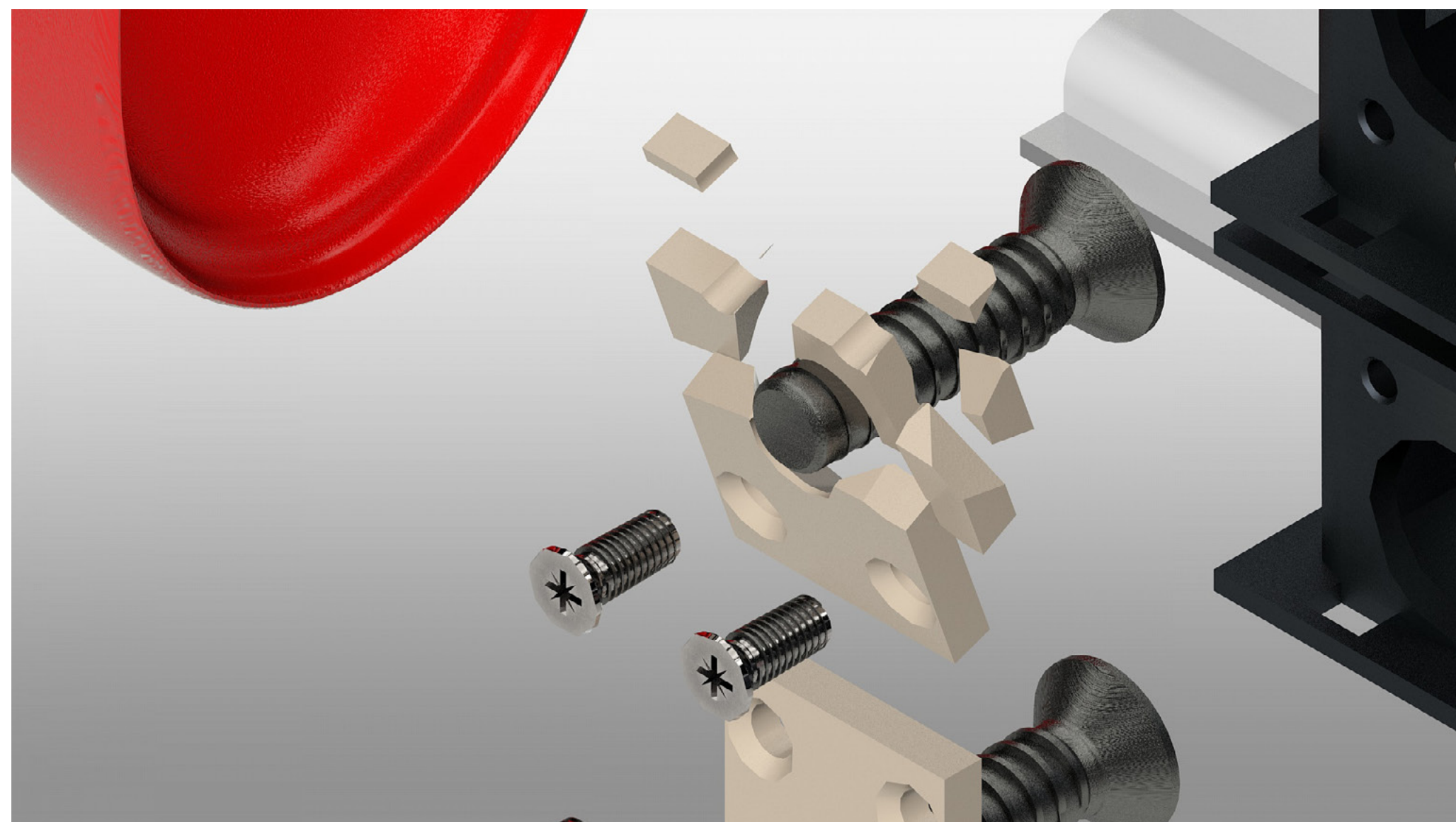
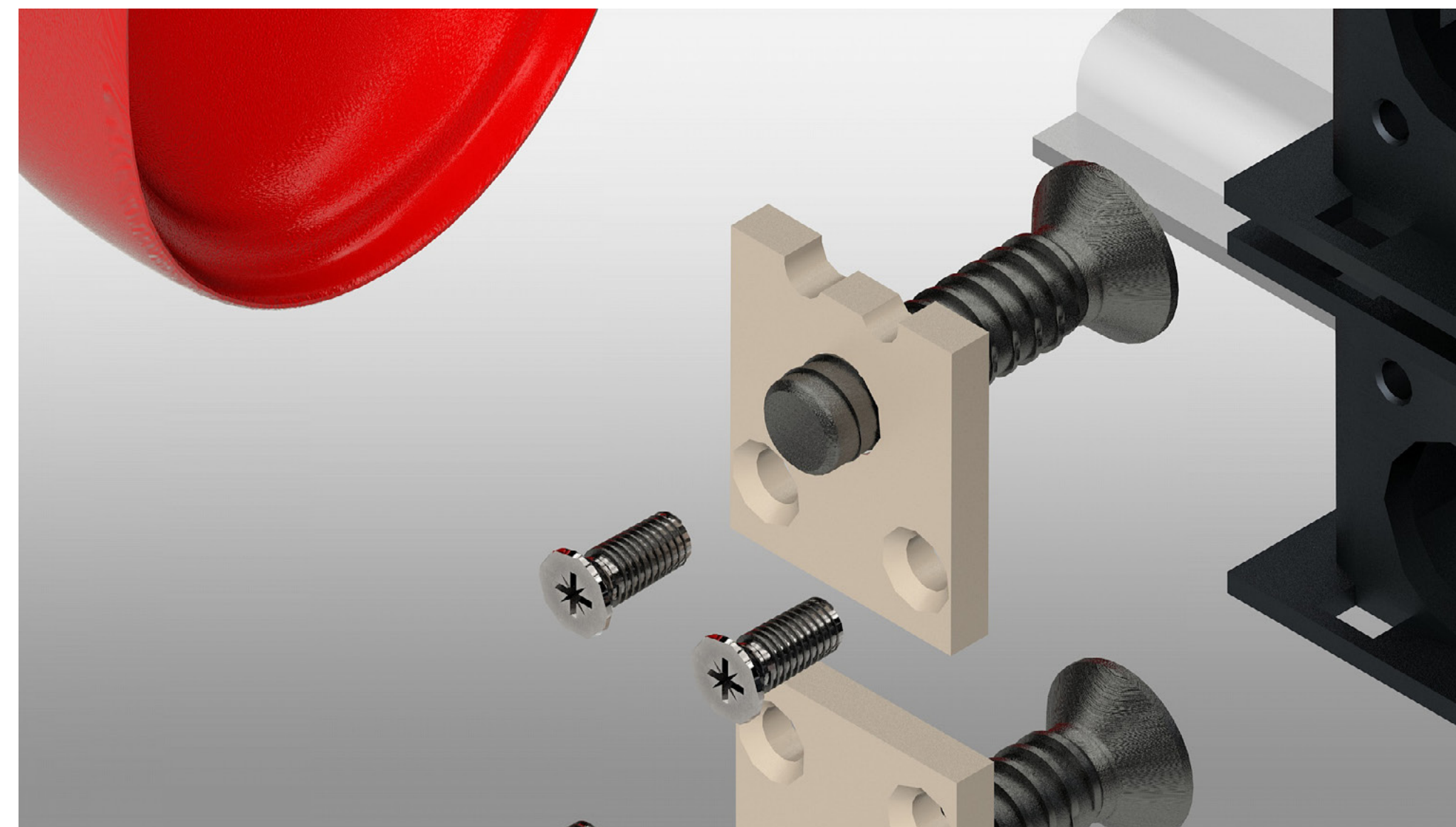
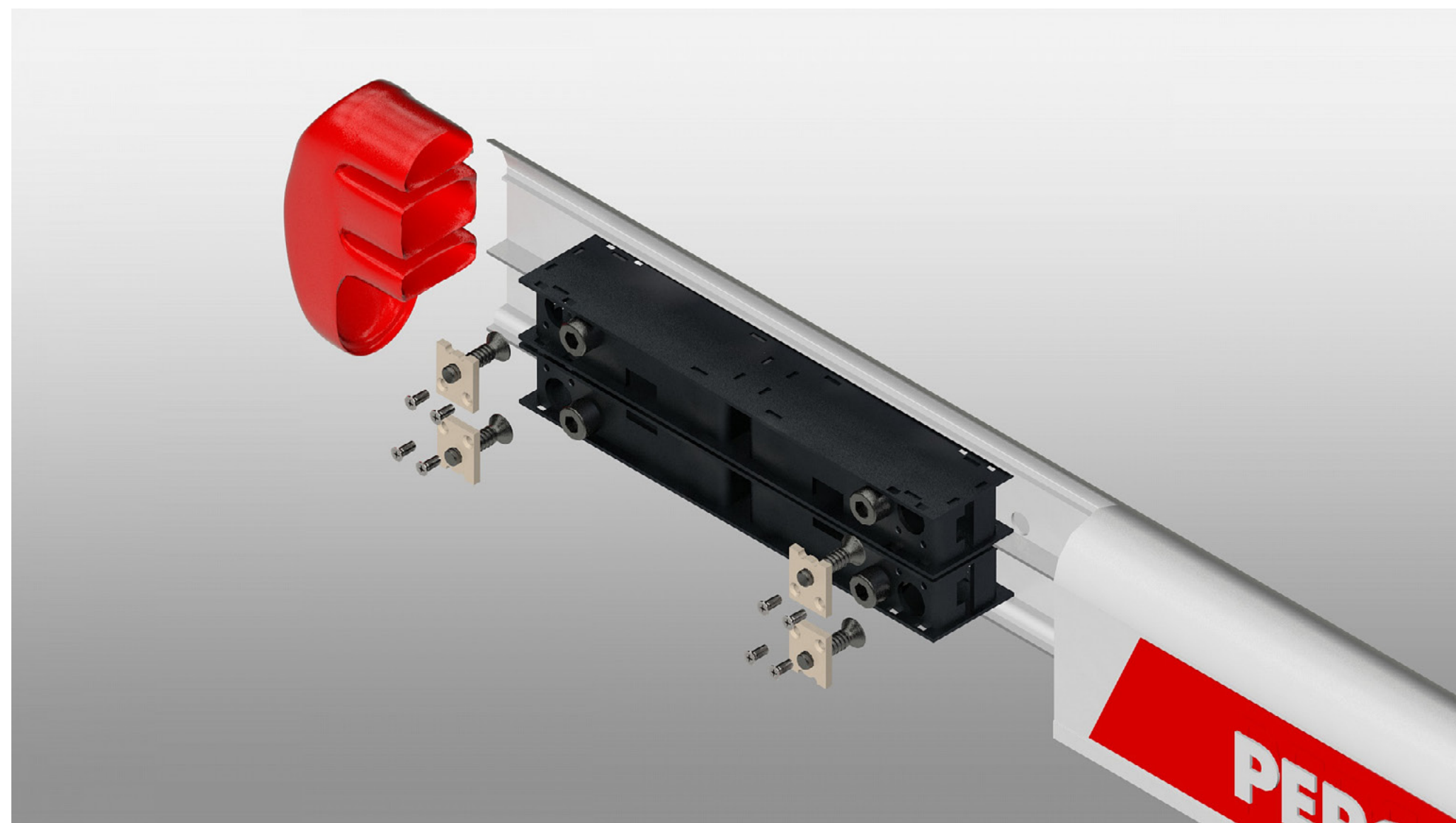

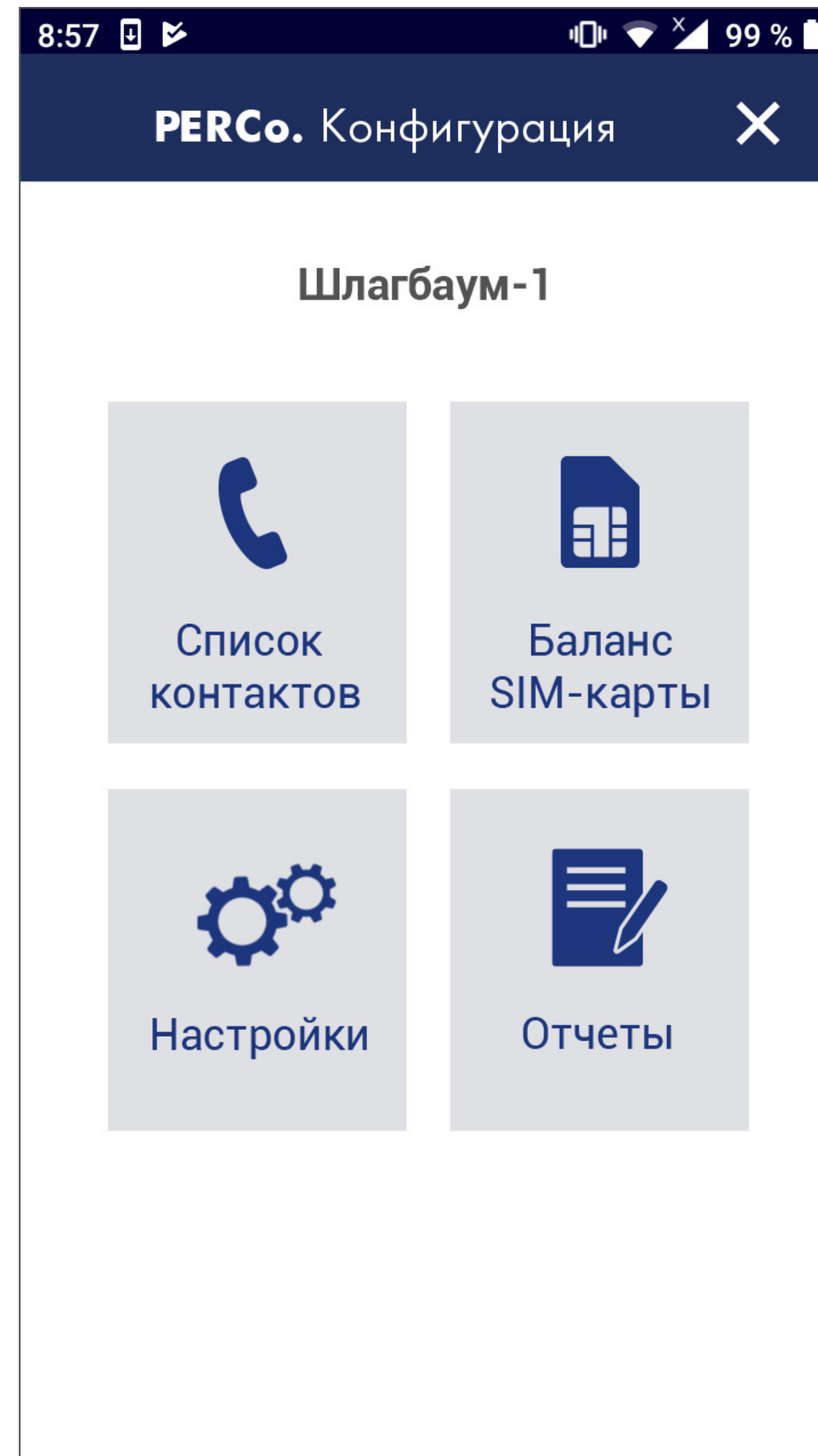
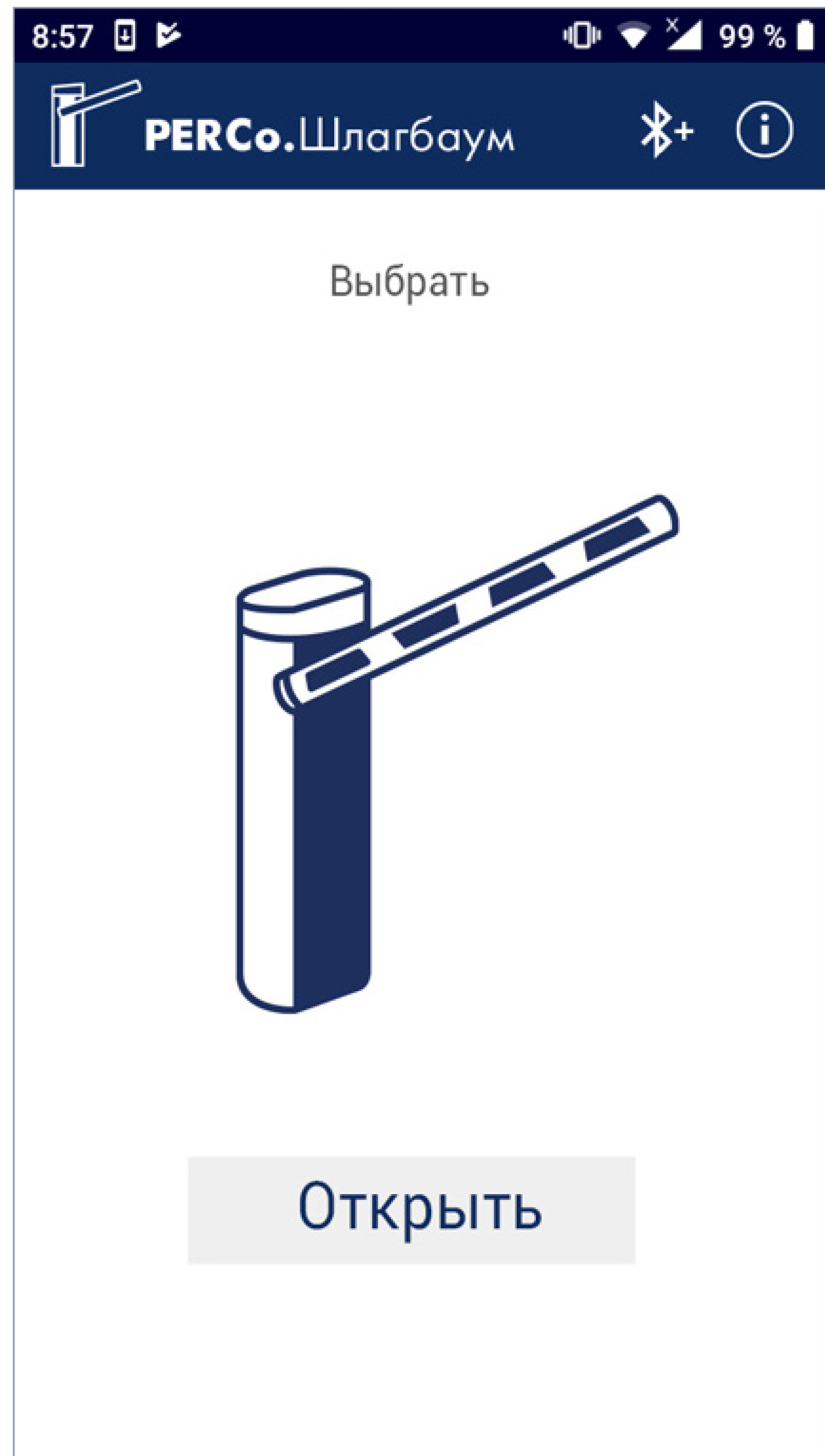

Модуль управления и конфигурирования

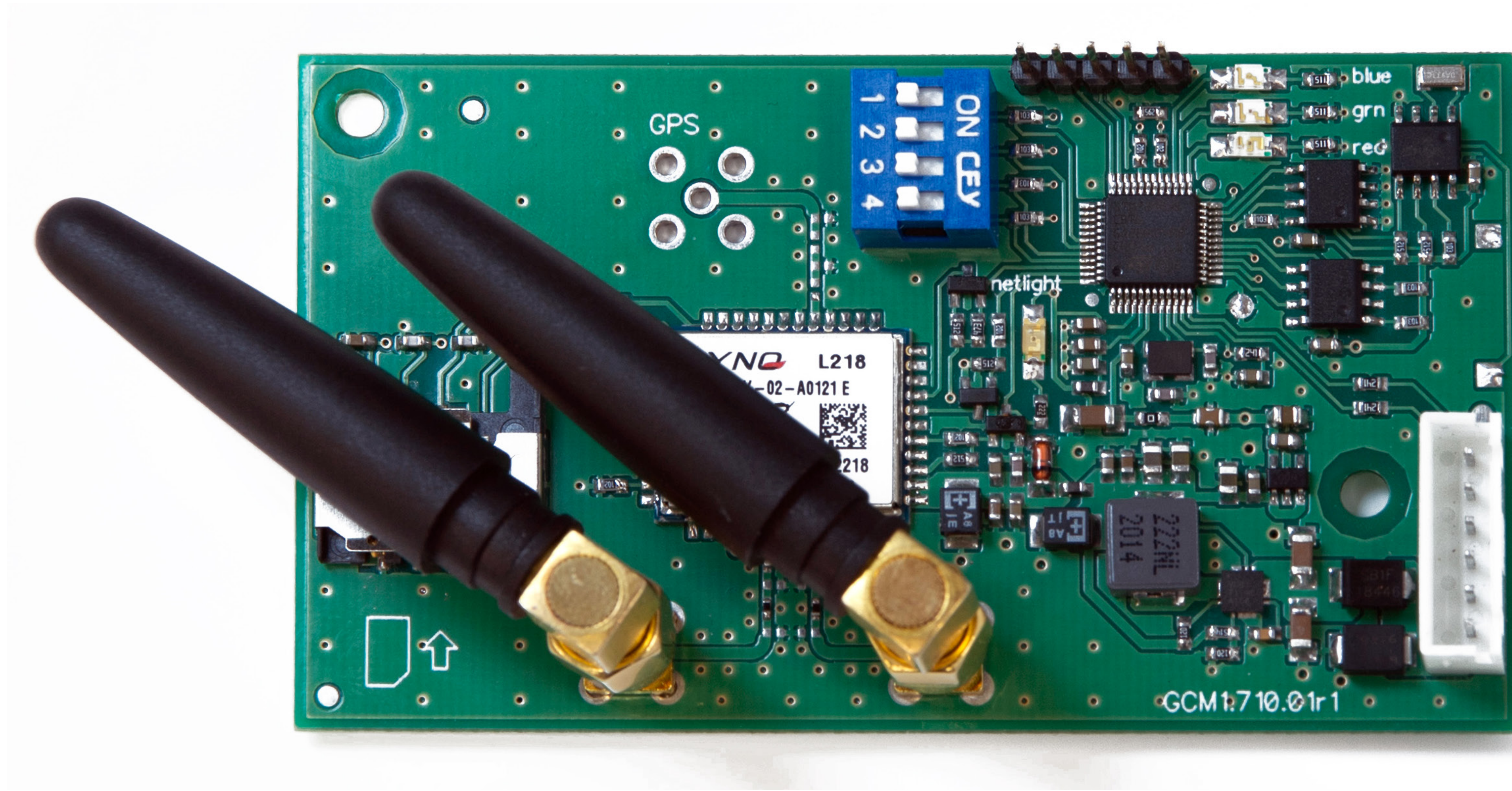



3000

телефонных номеров

abcdef
12345
#%@!?

50

текстовых символов для каждого номера



10 000

событий



15 м

дальность приема сигнала Bluetooth

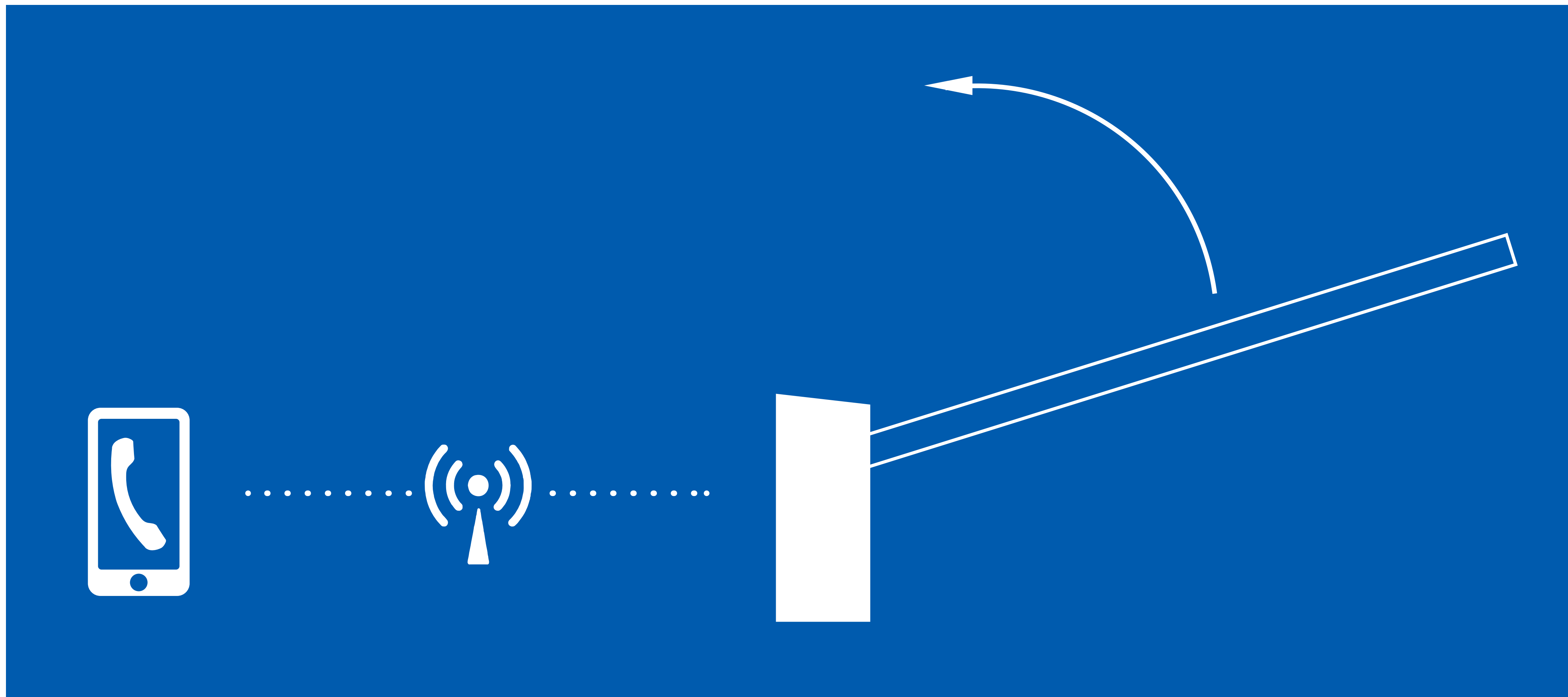

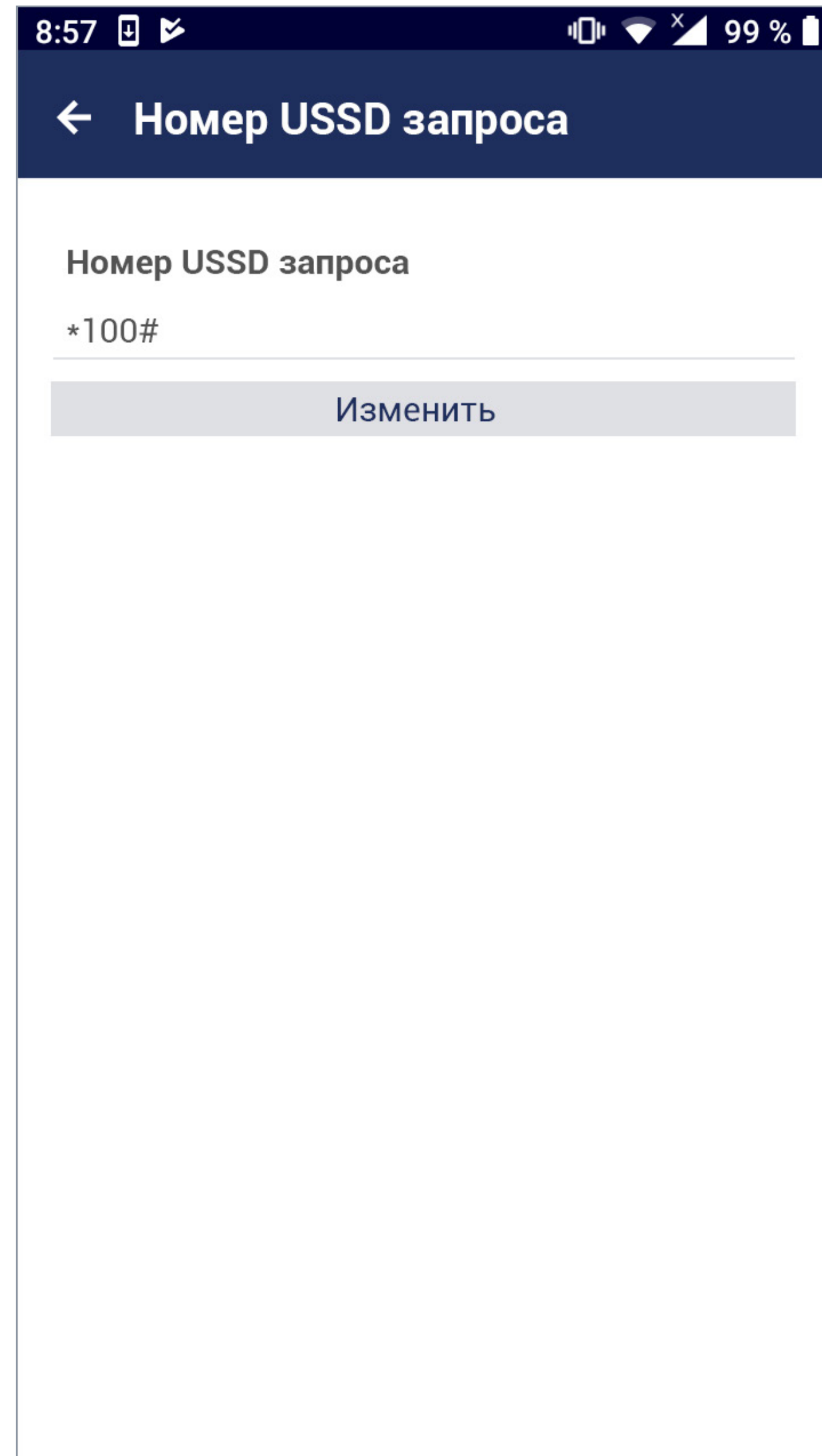
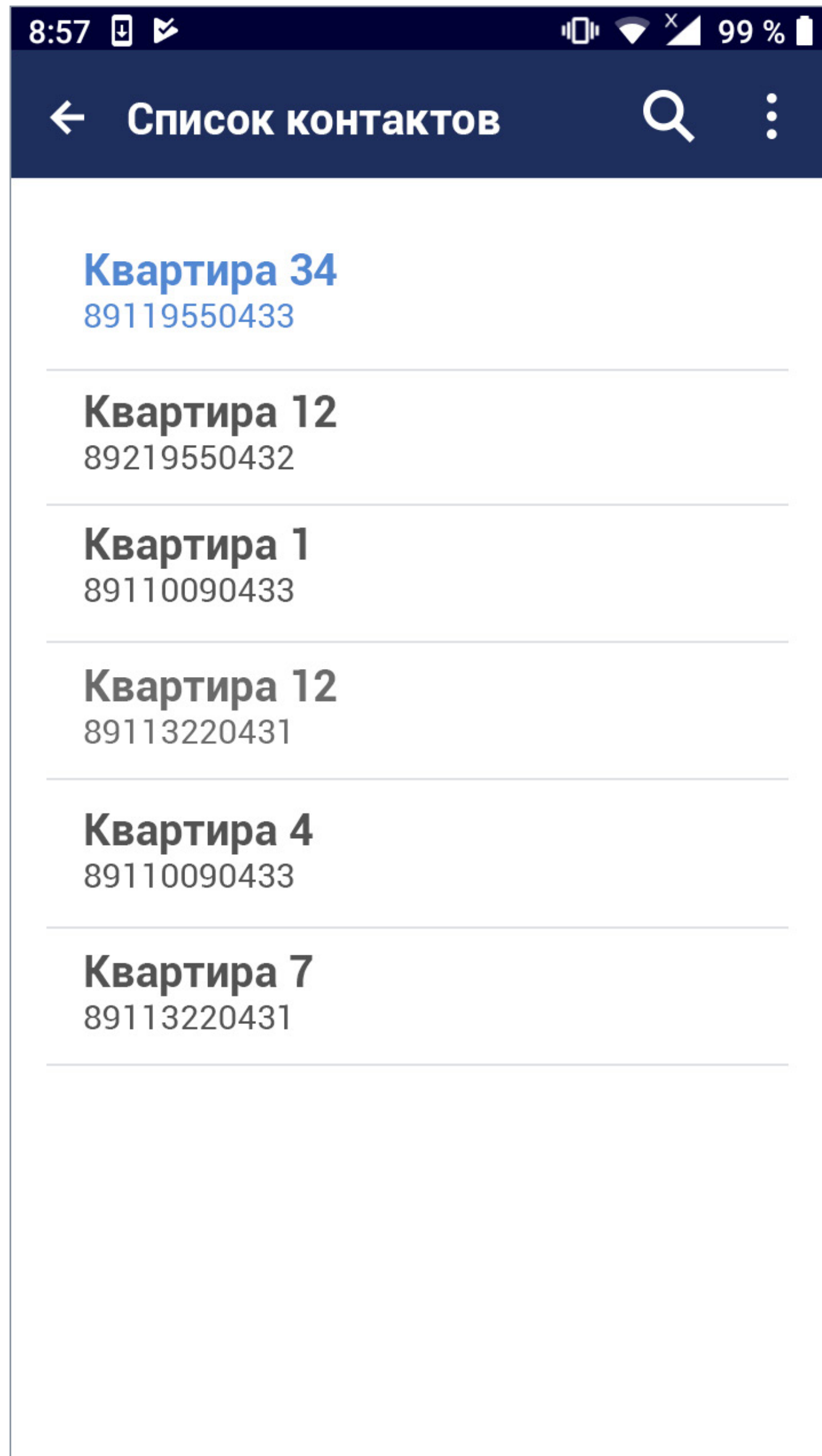

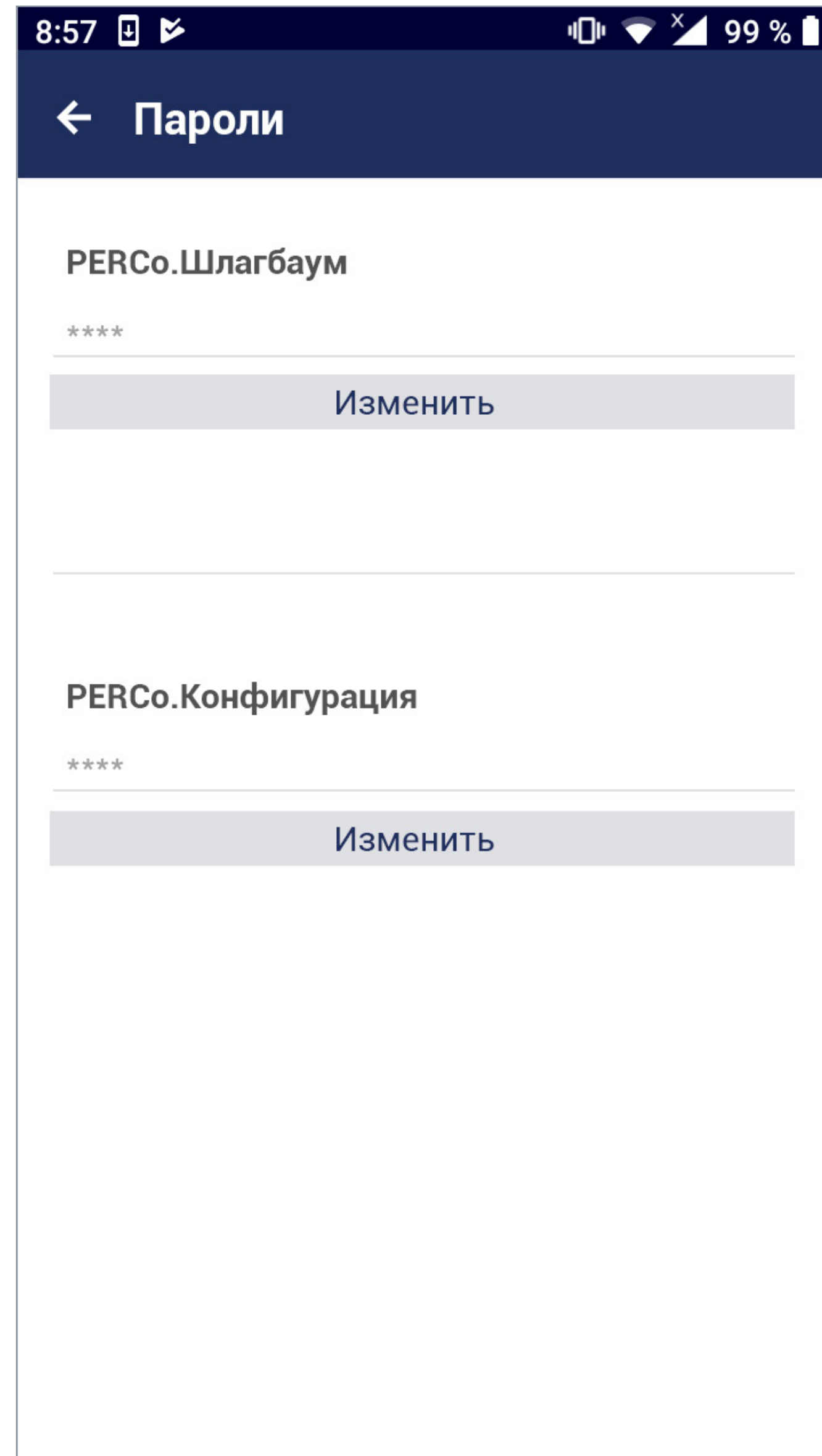
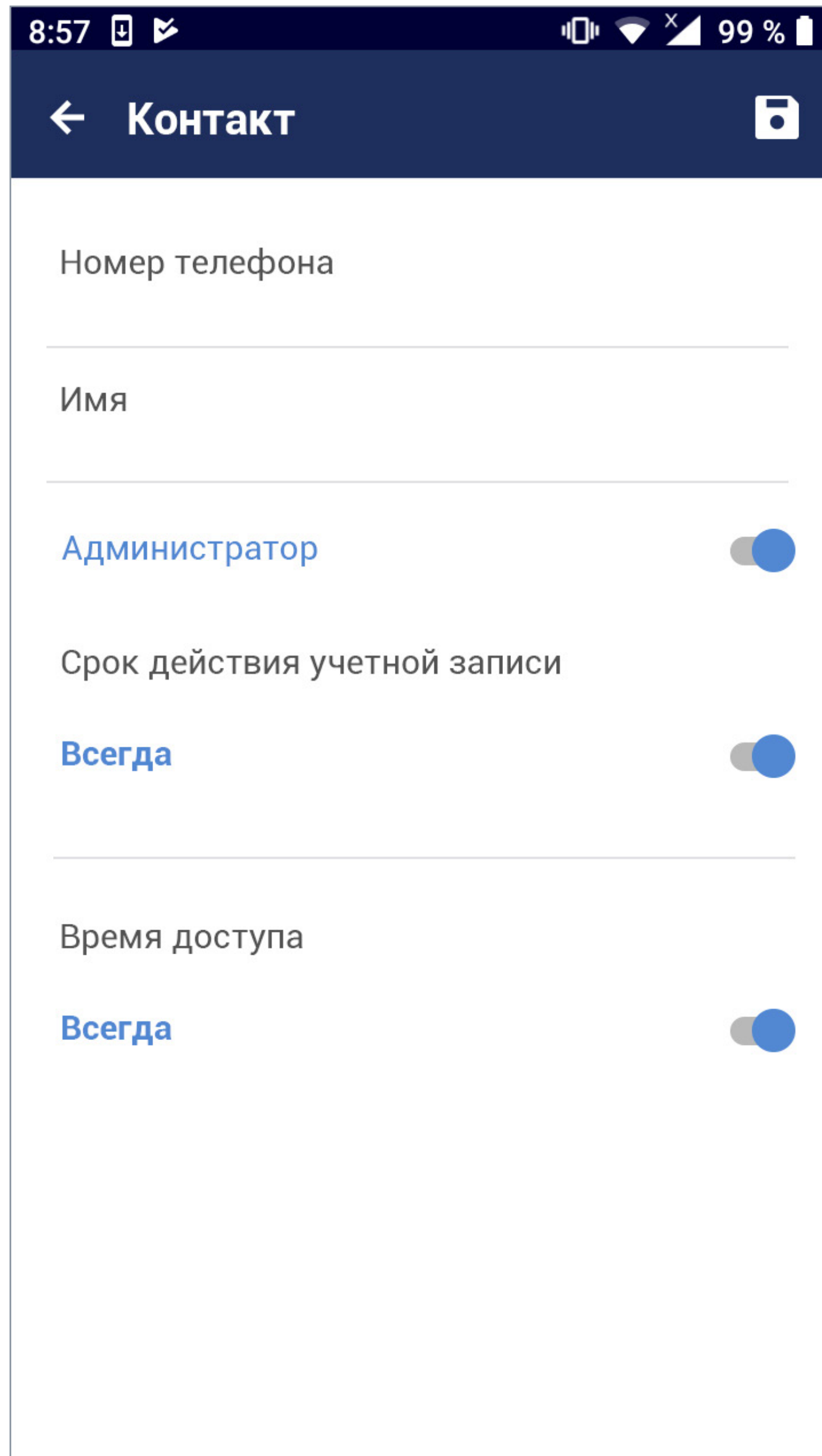

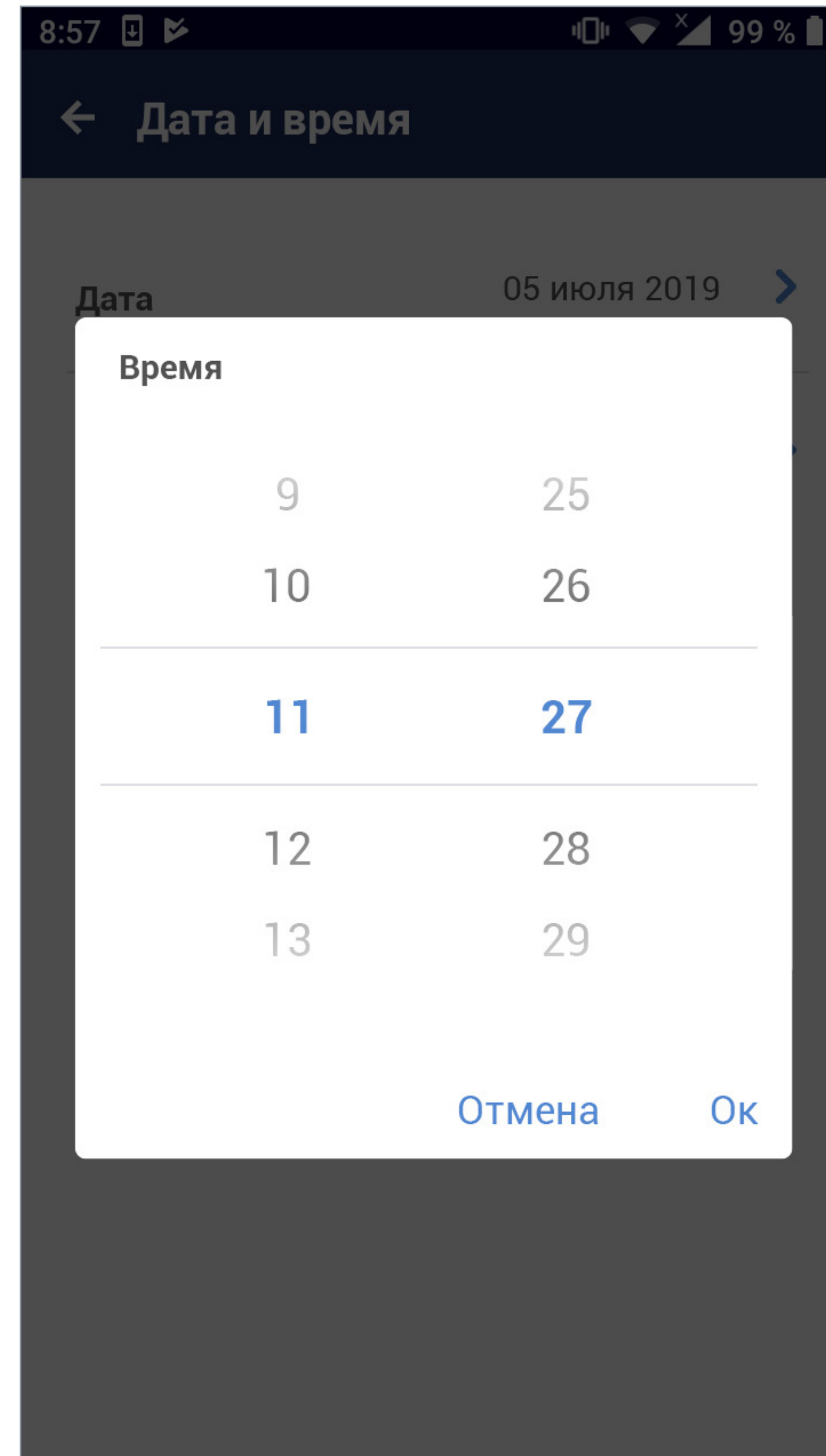
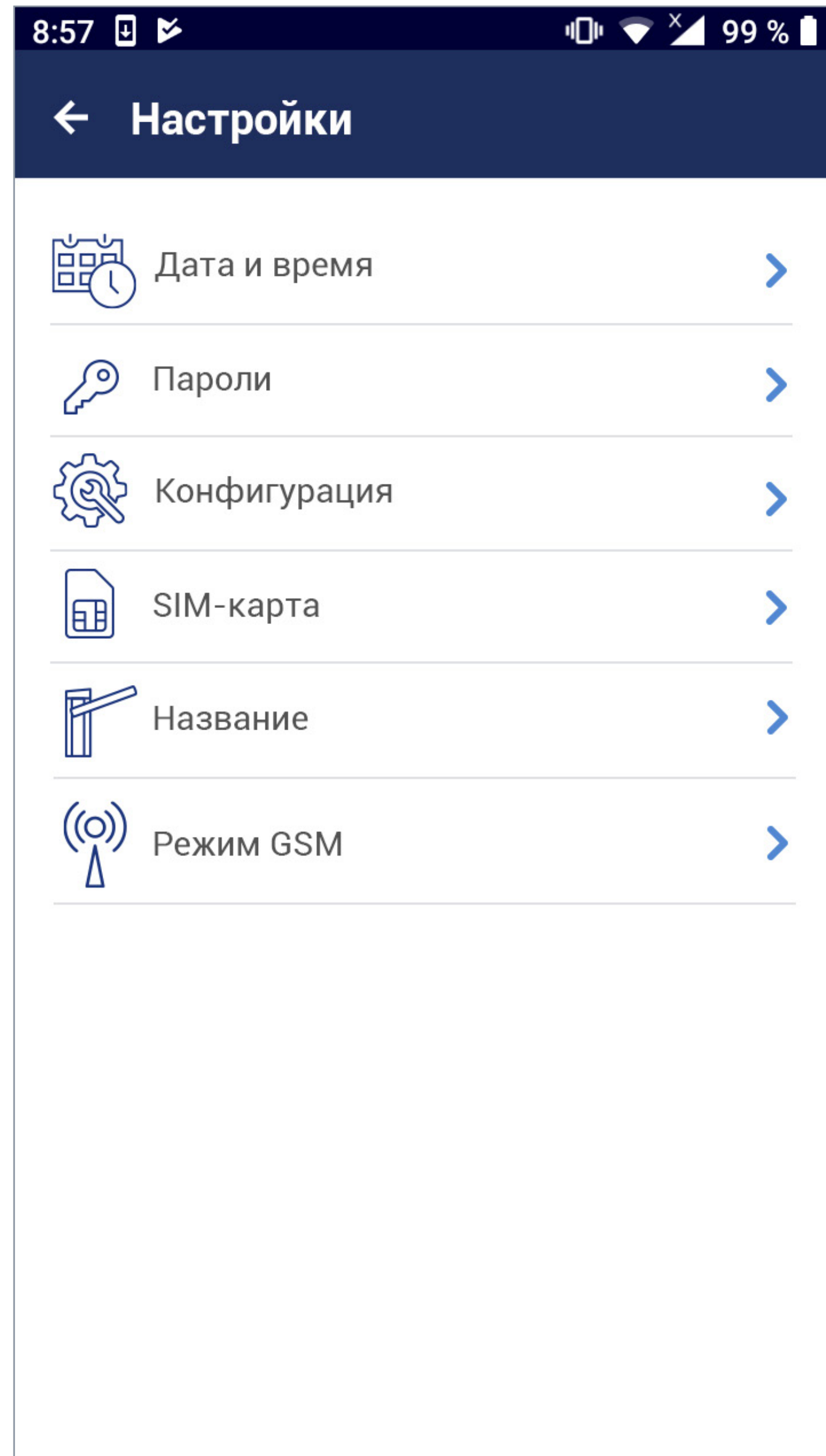

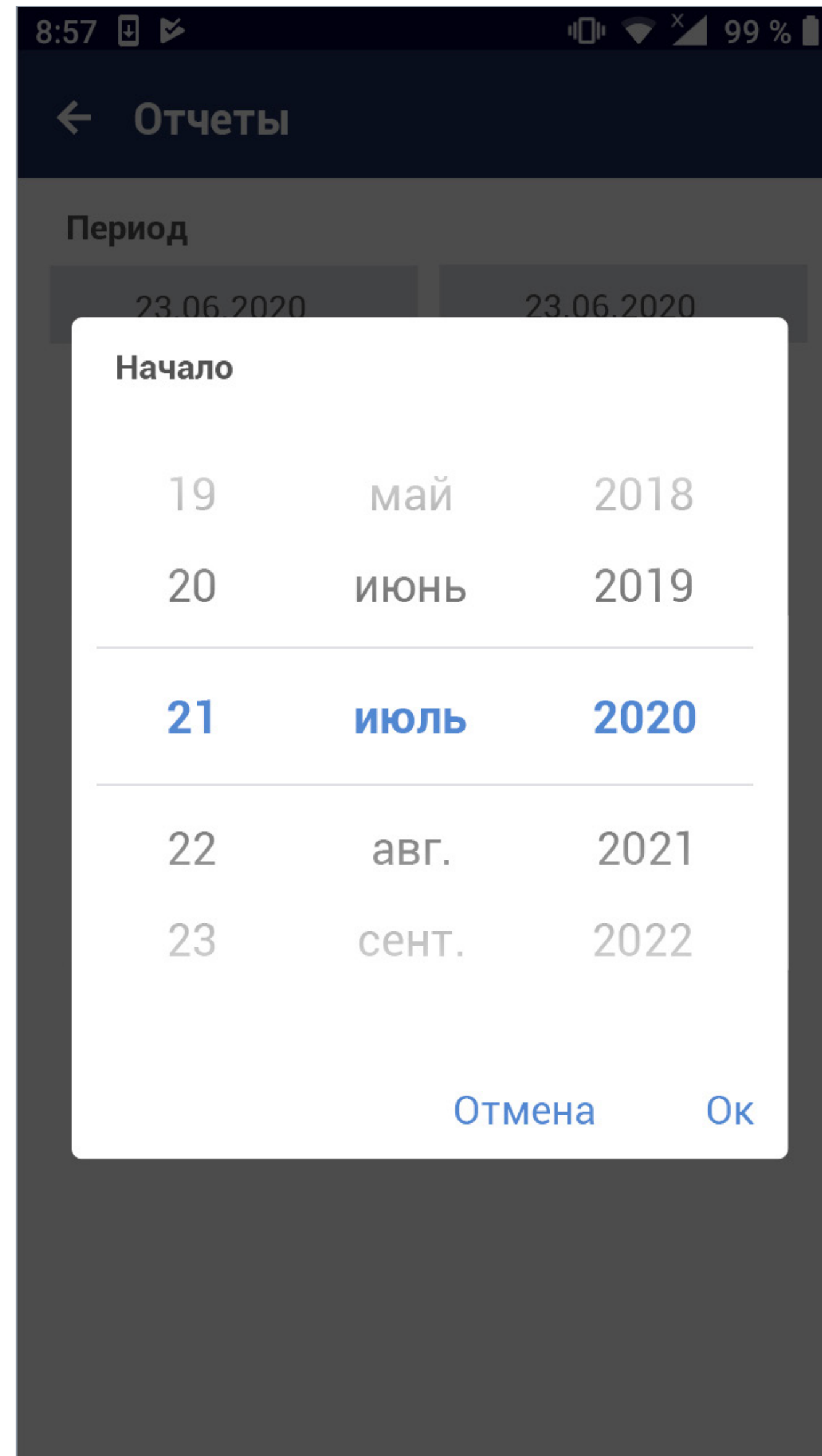
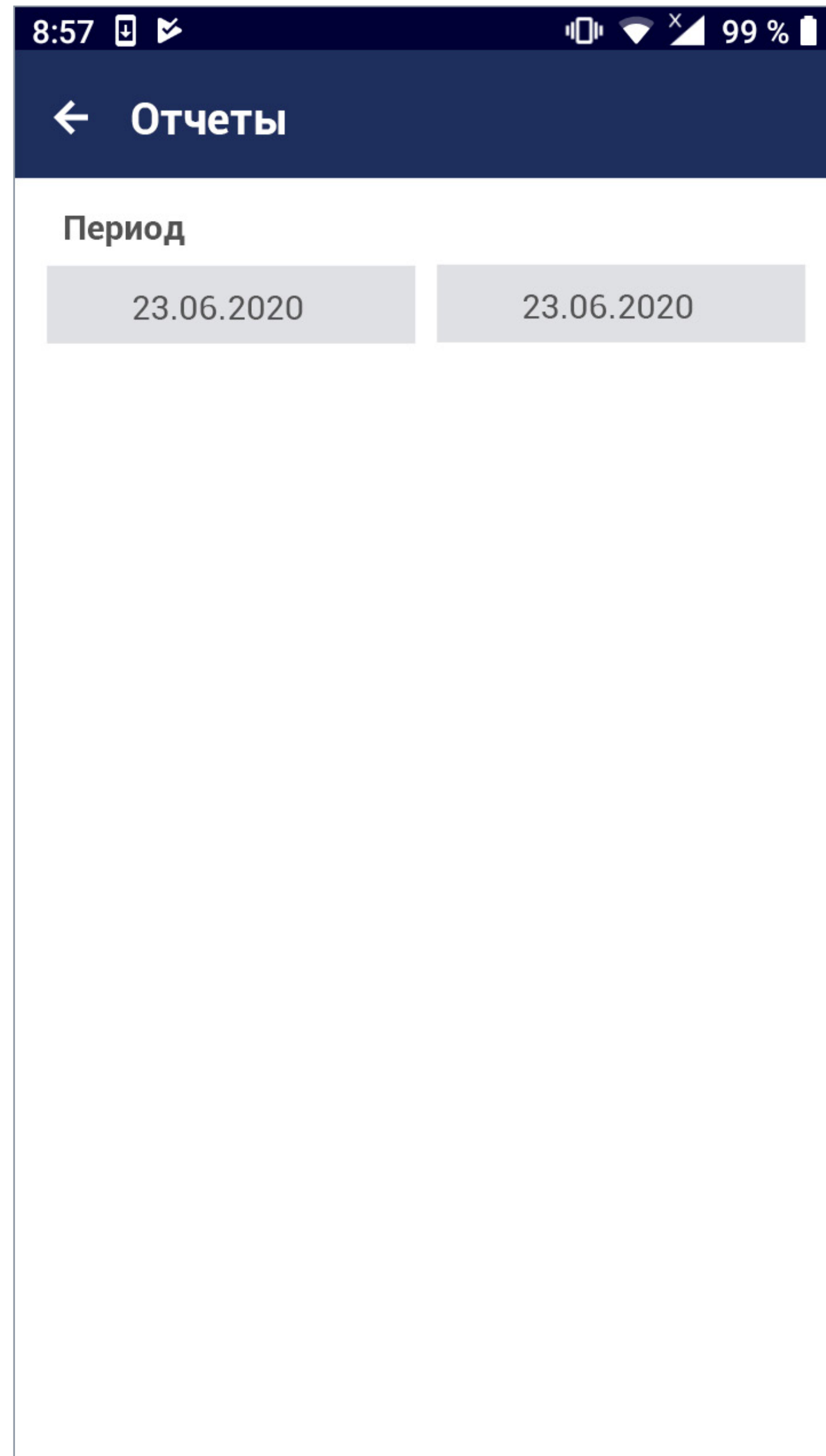

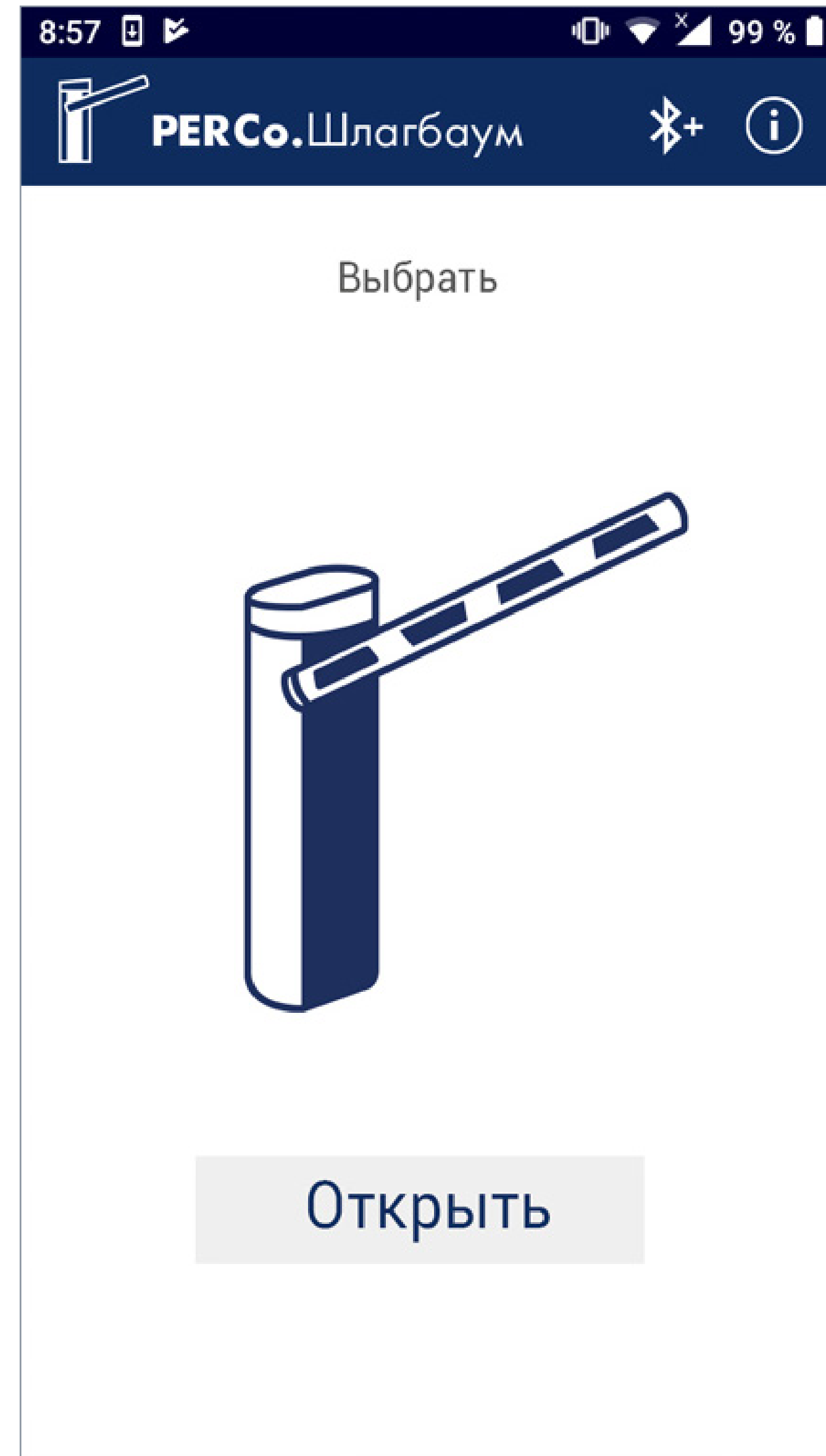
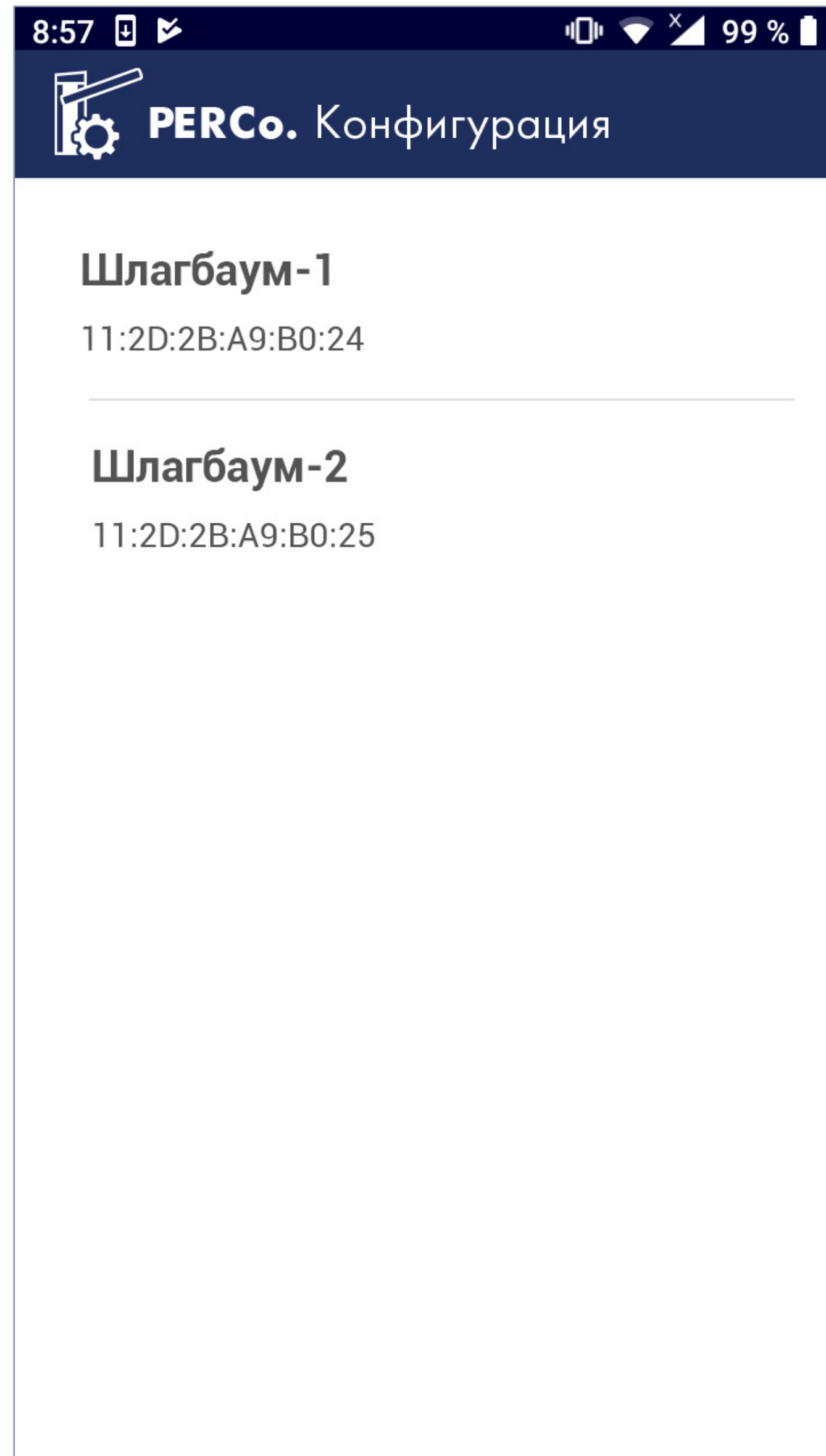

Шлагбаум PERCo-GS04

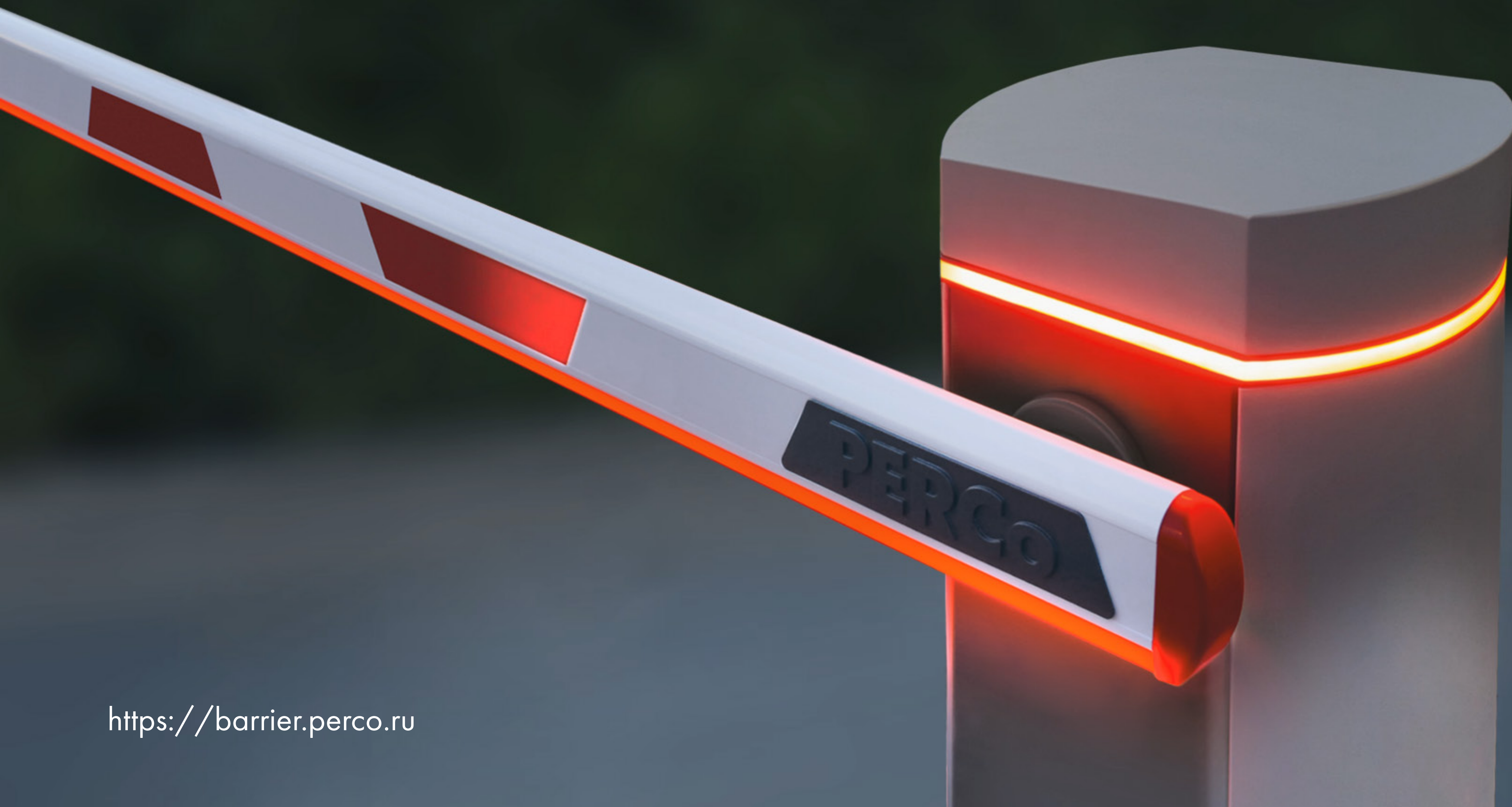

<https://barrier.perco.ru>



+7 (812) 247-04-59
seminar@perco.ru